

Understanding the Fundamental Principles of Vector Network Analysis

Introduction

In this application note, the fundamental principles of vector network analysis will be reviewed. The discussion includes the common parameters that can be measured, including the concept of scattering parameters (S-parameters). RF fundamentals such as transmission lines and the Smith chart will also be reviewed.

Network analysis is the process by which designers and manufacturers measure the electrical performance of the components and circuits used in more complex systems. When these systems are conveying signals with information content, we are most concerned with getting the signal from one point to another with maximum efficiency and minimum distortion. Vector network analysis is a method of accurately characterizing such components by measuring their effect on the amplitude and phase of swept-frequency and swept-power test signals.



Measurements in Communications Systems

In any communications system, the effect of signal distortion must be considered. While we generally think of the distortion caused by nonlinear effects (for example, when intermodulation products are produced from desired carrier signals), purely linear systems can also introduce signal distortion. Linear systems can change the time waveform of signals passing through them by altering the amplitude or phase relationships of the spectral components that make up the signal.

Let's examine the difference between linear and nonlinear behavior more closely.

Linear devices impose magnitude and phase changes on input signals (Figure 1). Any sinusoid appearing at the input will also appear at the output, and at the same frequency. No new signals are created. Both active and passive nonlinear devices can shift an input signal in frequency or add other frequency components, such as harmonic and spurious signals. Large input signals can drive normally linear devices into compression or saturation, causing nonlinear operation.

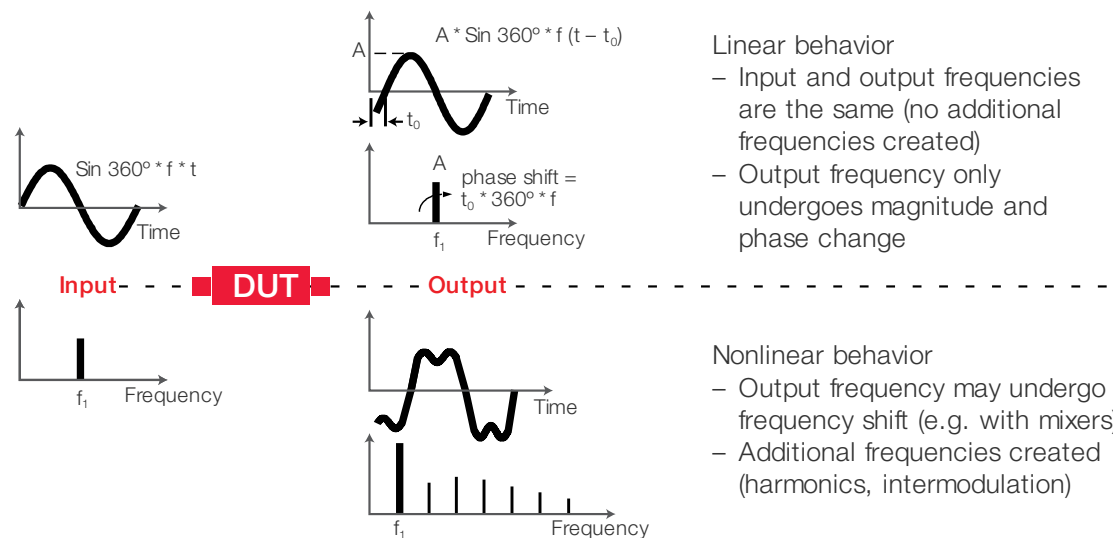

Figure 1. Linear versus nonlinear behavior

For linear distortion-free transmission, the amplitude response of the device under test (DUT) must be flat and the phase response must be linear over the desired bandwidth. As an example, consider a square-wave signal rich in high-frequency components passing through a bandpass filter that passes selected frequencies with little attenuation while attenuating frequencies outside of the passband by varying amounts.

Even if the filter has linear phase performance, the out-of-band components of the square wave will be attenuated, leaving an output signal that, in this example, is more sinusoidal in nature (Figure 2).

If the same square-wave input signal is passed through a filter that only inverts the phase of the third harmonic, but leaves the harmonic amplitudes the same, the output will be more impulse-like in nature (Figure 3). While this is true for the example filter, in general, the output waveform will appear with arbitrary distortion, depending on the amplitude and phase nonlinearities.

$$F(t) = \sin \omega t + \frac{1}{3} \sin 3\omega t + \frac{1}{5} \sin 5\omega t$$

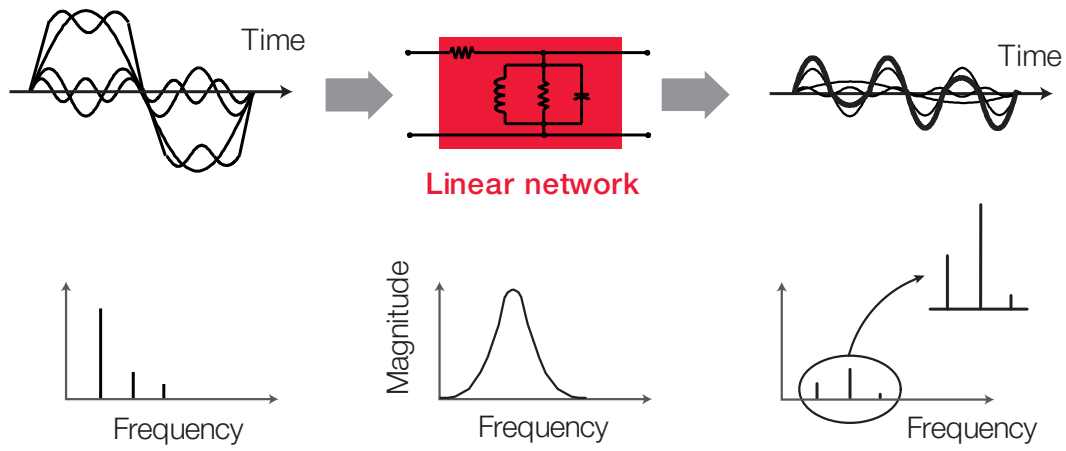

Figure 2. Magnitude variation with frequency

$$F(t) = \sin \omega t + \frac{1}{3} \sin 3\omega t + \frac{1}{5} \sin 5\omega t$$

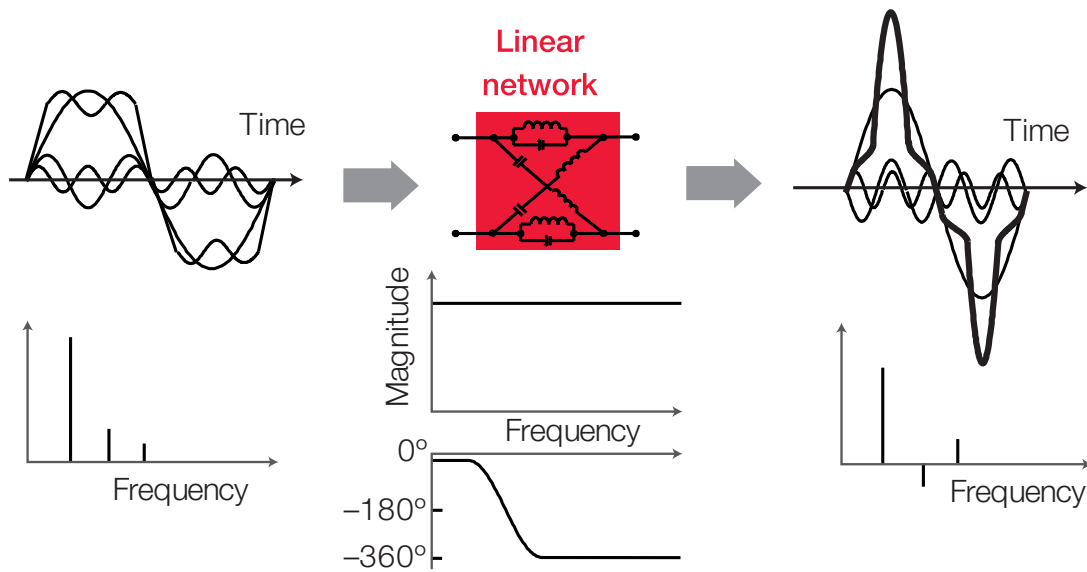

Figure 3. Phase variation with frequency

Nonlinear networks

Saturation, crossover, intermodulation, and other nonlinear effects can cause signal distortion

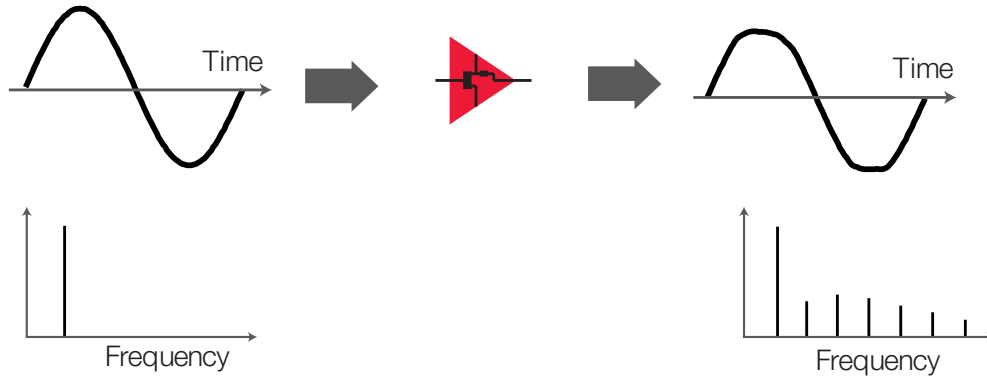

Figure 4. Nonlinear induced distortion

Nonlinear devices also introduce distortion (Figure 4). For example, if an amplifier is overdriven, the output signal clips because the amplifier is saturated. The output signal is no longer a pure sinusoid, and harmonics are present at multiples of the input frequency. Passive devices may also exhibit nonlinear behavior at high power levels, a good example of which is an L-C filter that uses inductors with magnetic cores. Magnetic materials often exhibit hysteresis effects that are highly nonlinear.

Efficient transfer of power is another fundamental concern in communications systems. In order to efficiently convey, transmit or receive RF power, devices such as transmission lines, antennas and amplifiers must present the proper impedance match to the signal source. Impedance mismatches occur when the real and imaginary parts of input and output impedances are not ideal between two connecting devices.

Importance of Vector Measurements

Measuring both magnitude and phase of components is important for several reasons. First, both measurements are required to fully characterize a linear network and ensure distortion-free transmission. To design efficient matching networks, complex impedance must be measured. Engineers developing models for computer-aided engineering (CAE) circuit simulation programs require magnitude and phase data for accurate models.

In addition, time-domain characterization requires magnitude and phase information in order to perform an inverse-Fourier transform. Vector error correction, which improves measurement accuracy by removing the effects of inherent measurement-system errors, requires both magnitude and phase data to build an effective error model. Phase-measurement capability is very important even for scalar measurements such as return loss, in order to achieve a high level of accuracy (see Keysight application note Applying Error Correction to Network Analyzer Measurements, literature number 5965-7709E).

The Basis of Incident and Reflected Power

In its fundamental form, vector network analysis involves the measurement of incident, reflected, and transmitted waves that travel along transmission lines. Using optical wavelengths as an analogy, when light strikes a clear lens (the incident energy), some of the light is reflected from the lens surface, but most of it continues through the lens (the transmitted energy) (Figure 5). If the lens has mirrored surfaces, most of the light will be reflected and little or none will pass through it.

While the wavelengths are different for RF and microwave signals, the principle is the same. Vector network analyzers accurately measure the incident, reflected, and transmitted energy, e.g., the energy that is launched onto a transmission line, reflected back down the transmission line toward the source (due to impedance mismatch) and successfully transmitted to the terminating device (such as an antenna).

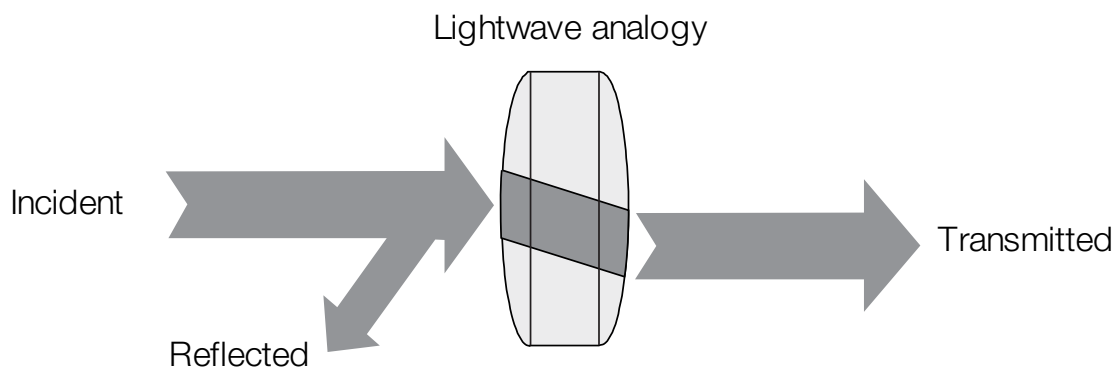

Figure 5. Lightwave analogy to high-frequency device characterization

The Smith Chart

The amount of reflection that occurs when characterizing a device depends on the impedance that the incident signal “sees.” Since any impedance can be represented with real and imaginary parts ($R + jX$ or $G + jB$), they can be plotted on a rectilinear grid known as the complex impedance plane. Unfortunately, an open circuit (a common RF impedance) appears at infinity on the real axis, and therefore cannot be shown.

The polar plot is useful because the entire impedance plane is covered. However, instead of plotting impedance directly, the complex reflection coefficient is displayed in vector form. The magnitude of the vector is the distance from the center of the display, and phase is displayed as the angle of vector referenced to a flat line from the center to the right-most edge. The drawback of polar plots is that impedance values cannot be read directly from the display.

Since there is a one-to-one correspondence between complex impedance and reflection coefficient, the positive real half of the complex impedance plane can be mapped onto the polar display. The result is the Smith chart. All values of reactance and all positive values of resistance from 0 to infinity fall within the outer circle of the Smith chart (Figure 6).

On the Smith chart, loci of constant resistance appear as circles, while loci of constant reactance appear as arcs. Impedances on the Smith chart are always normalized to the characteristic impedance of the component or system of interest, usually 50 ohms for RF and microwave systems and 75 ohms for broadcast and cable-television systems. A perfect termination appears in the center of the Smith chart.

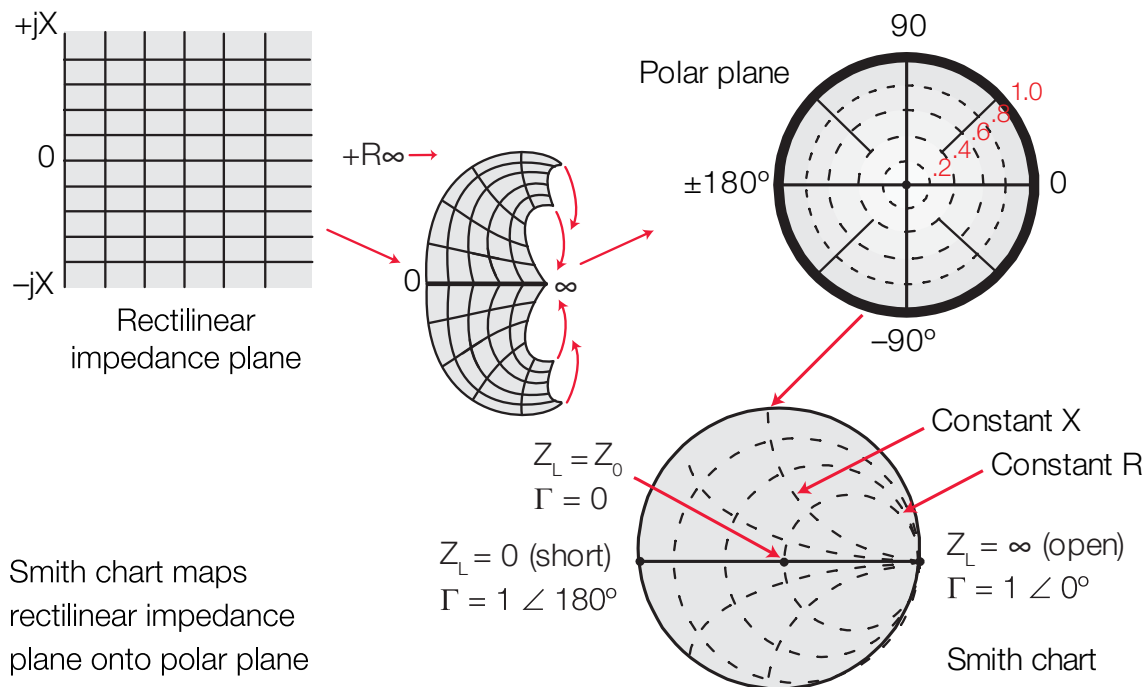

Figure 6. Smith chart review

Power Transfer Conditions

A perfectly matched condition must exist at a connection between two devices for maximum power transfer into a load, given a source resistance of R_S and a load resistance of R_L . This condition occurs when $R_L = R_S$ and is true whether the stimulus is a DC voltage source or a source of RF sine waves (Figure 7).

When the source impedance is not purely resistive, maximum power transfer occurs when the load impedance is equal to the complex conjugate of the source impedance. This condition is met by reversing the sign of the imaginary part of the impedance. For example, if $R_S = 0.6 + j 0.3$, then the complex conjugate is $R_S^* = 0.6 - j 0.3$.

The need for efficient power transfer is one of the main reasons for the use of transmission lines at higher frequencies. At very low frequencies (with much larger wavelengths), a simple wire is adequate for conducting power. The resistance of the wire is relatively low and has little effect on low-frequency signals. The voltage and current are the same no matter where a measurement is made on the wire.

At higher frequencies, wavelengths are comparable to or smaller than the length of the conductors in a high-frequency circuit, and power transmission can be thought of in terms of traveling waves. When the transmission line is terminated in its characteristic impedance, maximum power is transferred to the load. When the termination is not equal to the characteristic impedance, that part of the signal that is not absorbed by the load is reflected back to the source.

If a transmission line is terminated in its characteristic impedance, no reflected signal occurs since all of the transmitted power is absorbed by the load (Figure 8). Looking at the envelope of the RF signal versus distance along the transmission line shows no standing waves because, without reflections, energy flows in only one direction.

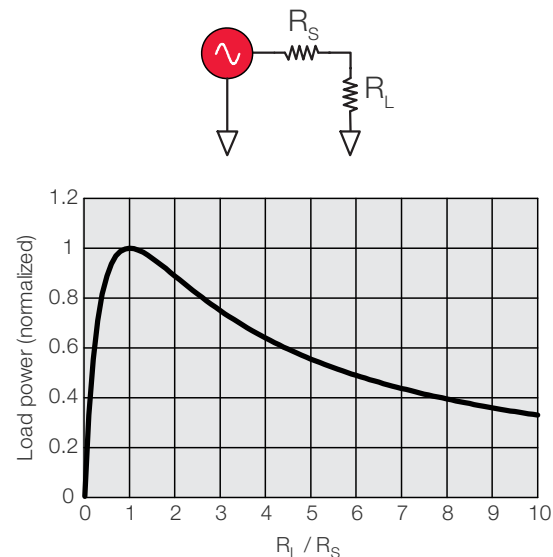

Maximum power is transferred when $R_L = R_S$

For complex impedances, maximum power transfer occurs when $Z_L = Z_S^*$ (conjugate match)

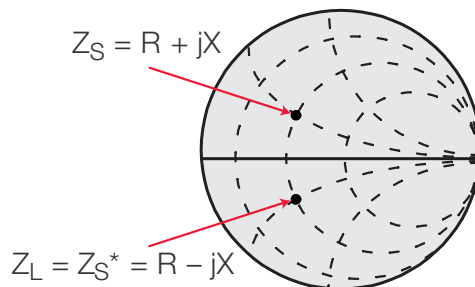
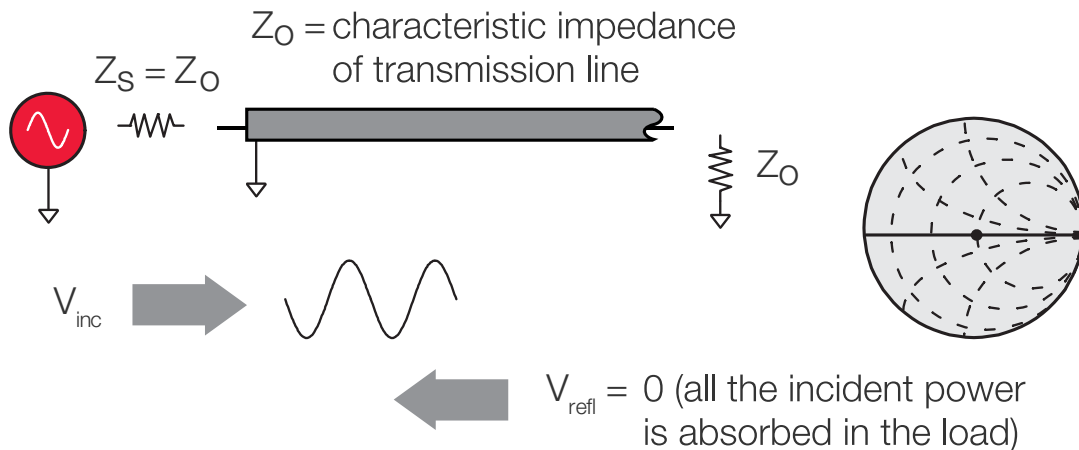

Figure 7. Power transfer



For reflection, a transmission line terminated in Z_0 behaves like an infinitely long transmission line

Figure 8. Transmission line terminated with Z_0

When the transmission line is terminated in a short circuit (which can sustain no voltage and therefore dissipates zero power), a reflected wave is launched back along the line toward the source (Figure 9). The reflected voltage wave must be equal in magnitude to the incident voltage wave and be 180 degrees out of phase with it at the plane of the load. The reflected and incident waves are equal in magnitude but traveling in opposite directions.

If the transmission line is terminated in an open-circuit condition (which can sustain no current), the reflected current wave will be 180 degrees out of phase with the incident current wave, while the reflected voltage wave will be in phase with the incident voltage wave at the plane of the load. This guarantees that the current at the open will be zero. The reflected and incident current waves are equal in magnitude but traveling in opposite directions. For both the short and open cases, a standing wave pattern is set up on the transmission line. The voltage valleys will be zero and the voltage peaks will be twice the incident voltage level.

If the transmission line is terminated with say a 25-ohm resistor, resulting in a condition between full absorption and full reflection, part of the incident power is absorbed and part is reflected. The amplitude of the reflected voltage wave will be one-third that of the incident wave, and the two waves will be 180 degrees out of phase at the plane of the load. The valleys of the standing-wave pattern will no longer be zero, and the peaks will be less than those of the short and open cases. The ratio of the peaks to valleys will be 2:1.

The traditional way of determining RF impedance was to measure VSWR using an RF probe/detector, a length of slotted transmission line, and a VSWR meter. As the probe was moved along the transmission line, the relative position and values of the peaks and valleys were noted on the meter. From these measurements, impedance could be derived. The procedure was repeated at different frequencies. Modern vector network analyzers measure the incident and reflected waves directly during a frequency sweep, and impedance results can be displayed in any number of formats (including VSWR).

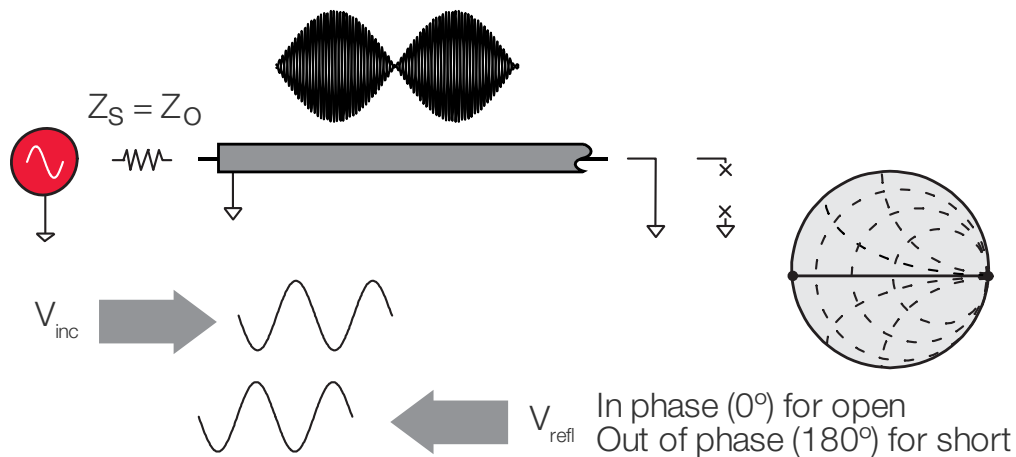

For reflection, a transmission line terminated in a short or open reflects all power back to source

Figure 9. Transmission line terminated with short, open

Vector Network Analysis Terminology

Now that we understand the fundamentals of electromagnetic waves, we must learn the common terms used for measuring them. Vector network analyzer terminology generally denotes measurements of the incident wave with the R or reference channel. The reflected wave is measured with the A channel, and the transmitted wave is measured with the B channel (Figure 10). With the amplitude and phase information in these waves, it is possible to quantify the reflection and transmission characteristics of a DUT. The reflection and transmission characteristics can be expressed as vector (magnitude and phase), scalar (magnitude only), or phase-only quantities. For example, return loss is a scalar measurement of reflection, while impedance is a vector reflection measurement. Ratioed measurements allow us to make reflection and transmission measurements that are independent of both absolute power and variations in source power versus frequency. Ratioed reflection is often shown as A/R and ratioed transmission as B/R , relating to the measurement channels in the instrument.

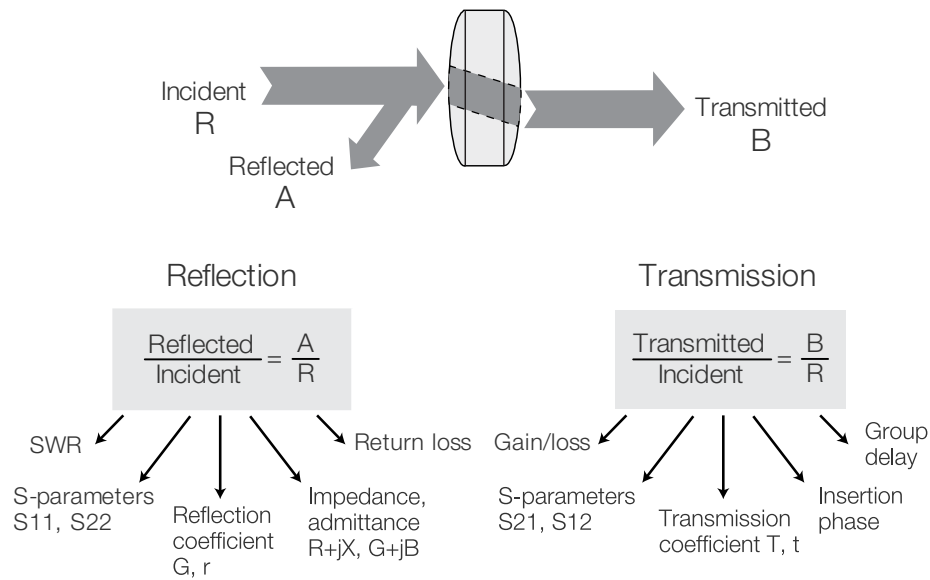
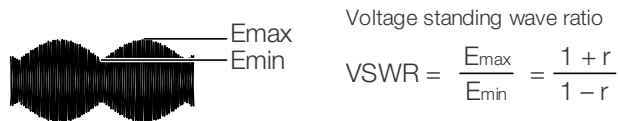

Figure 10. Common terms for high-frequency device characterization

The most general term for ratioed reflection is the complex reflection coefficient, ρ or gamma (Figure 11). The magnitude portion of ρ is called π or rho. The reflection coefficient is the ratio of the reflected signal voltage level to the incident signal voltage level. For example, a transmission line terminated in its characteristic impedance Z_0 , will have all energy transferred to the load so $V_{\text{refl}} = 0$ and $\pi = 0$. When the impedance of the load, Z_L is not equal to the characteristic impedance, energy is reflected and π is greater than zero. When the load impedance is equal to a short or open circuit, all energy is reflected and $\pi = 1$. As a result, the range of possible values for π is 0 to 1.

Reflection coefficient $G = \frac{V_{\text{reflected}}}{V_{\text{incident}}} = r \angle F = \frac{Z_L - Z_0}{Z_L + Z_0}$

Return loss $= -20 \log(r), r = |G|$



No reflection ($Z_L = Z_0$)		Full reflection ($Z_L = \text{open, short}$)
0	r	1
∞ dB	RL	0 dB
1	VSWR	∞

Figure 11. Reflection parameters

Return loss is a way to express the reflection coefficient in logarithmic terms (decibels). Return loss is the number of decibels that the reflected signal is below the incident signal. Return loss is always expressed as a positive number and varies between infinity for a load at the characteristic impedance and 0 dB for an open or short circuit. Another common term used to express reflection is voltage standing wave ratio (VSWR), which is defined as the maximum value of the RF envelope over the minimum value of the RF envelope. It is related to ρ as $(1 + \rho)/(1 - \rho)$. VSWR ranges from 1 (no reflection) to infinity (full reflection).

The transmission coefficient is defined as the transmitted voltage divided by the incident voltage (Figure 12). If the absolute value of the transmitted voltage is greater than the absolute value of the incident voltage, a DUT or system is said to have gain. If the absolute value of the transmitted voltage is less than the absolute value of the incident voltage, the DUT or system is said to have attenuation or insertion loss. The phase portion of the transmission coefficient is called insertion phase.



$$\text{Transmission coefficient} = T = \frac{V_{\text{Transmitted}}}{V_{\text{Incident}}} = \tau \angle \phi$$

$$\text{Insertion loss (dB)} = -20 \text{ Log} \left| \frac{V_{\text{Trans}}}{V_{\text{Inc}}} \right| = -20 \log \tau$$

$$\text{Gain (dB)} = 20 \text{ Log} \left| \frac{V_{\text{Trans}}}{V_{\text{Inc}}} \right| = 20 \log \tau$$

Figure 12. Transmission parameters

Direct examination of insertion phase usually does not provide useful information. This is because the insertion phase has a large (negative) slope with respect to frequency due to the electrical length of the DUT. The slope is proportional to the length of the DUT. Since it is only deviation from linear phase that causes distortion in communications systems, it is desirable to remove the linear portion of the phase response to analyze the remaining nonlinear portion. This can be done by using the electrical delay feature of a vector network analyzer to mathematically cancel the average electrical length of the DUT. The result is a high-resolution display of phase distortion or deviation from linear phase (Figure 13).

Use electrical delay to remove linear portion of phase response

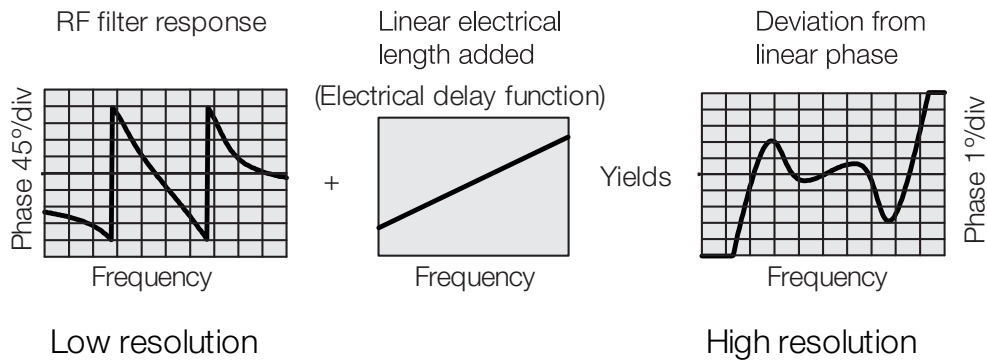

Figure 13. Deviation from linear phase

Measuring Group Delay

Another useful measure of phase distortion is group delay (Figure 14). This parameter is a measure of the transit time of a signal through a DUT versus frequency. Group delay can be calculated by differentiating the DUT's phase response versus frequency. It reduces the linear portion of the phase response to a constant value and transforms the deviations from linear phase into deviations from constant group delay, (which causes phase distortion in communications systems). The average delay represents the average signal transit time through a DUT.

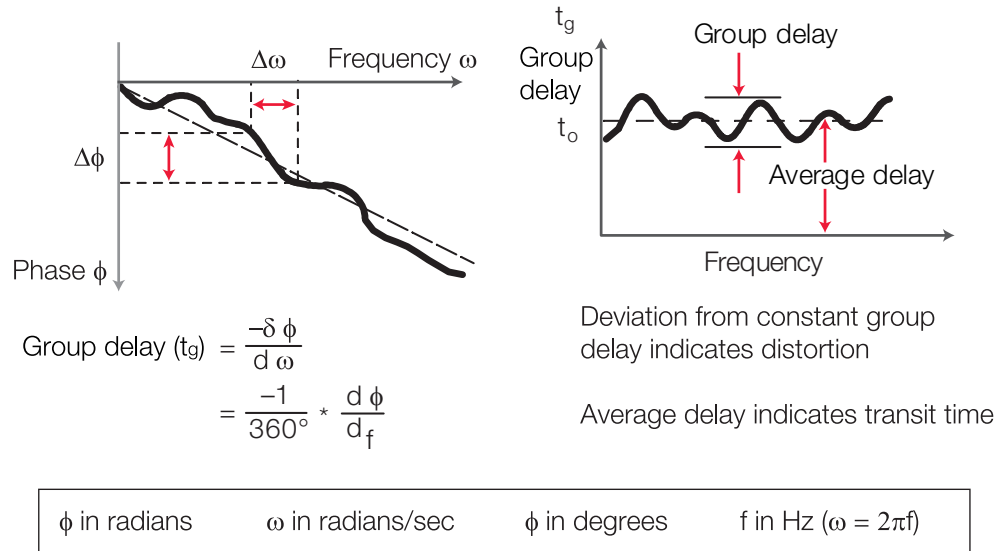

Figure 14. What is group delay?

Depending on the device, both deviation from linear phase and group delay may be measured, since both can be important. Specifying a maximum peak-to-peak phase ripple in a device may not be sufficient to completely characterize it, since the slope of the phase ripple depends on the number of ripples that occur per unit of frequency. Group delay takes this into account because it is the differentiated phase response. Group delay is often a more easily interpreted indication of phase distortion (Figure 15).

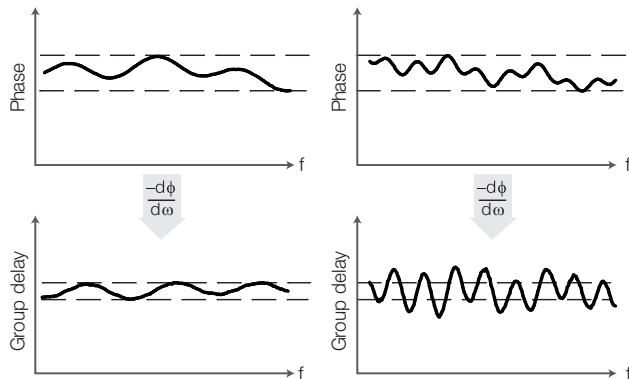

Figure 15. Same peak-to-peak phase ripple can result in different group delay

Network Characterization

In order to completely characterize an unknown linear two-port device, we must make measurements under various conditions and compute a set of parameters. These parameters can be used to completely describe the electrical behavior of our device (or network), even under source and load conditions other than when we made our measurements. Low-frequency device or network characterization is usually based on measurement of H, Y, and Z parameters. To do this, the total voltage and current at the input or output ports of a device or nodes of a network must be measured. Furthermore, measurements must be made with open-circuit and short-circuit conditions.

Since it is difficult to measure total current or voltage at higher frequencies, S-parameters are generally measured instead (Figure 16). These parameters relate to familiar measurements such as gain, loss, and reflection coefficient. They are relatively simple to measure, and do not require connection of undesirable loads to the DUT. The measured S-parameters of multiple devices can be cascaded to predict overall system performance. S-parameters are readily used in both linear and nonlinear CAE circuit simulation tools, and H, Y, and Z parameters can be derived from S-parameters when necessary.

The number of S-parameters for a given device is equal to the square of the number of ports. For example, a two-port device has four S-parameters. The numbering convention for S-parameters is that the first number following the S is the port at which energy emerges, and the second number is the port at which energy enters. So S₂₁ is a measure of power emerging from Port 2 as a result of applying an RF stimulus to Port 1. When the numbers are the same (e.g., S₁₁), a reflection measurement is indicated.

H, Y, and Z parameters

- Hard to measure total voltage and current at device ports at high frequencies
- Active devices may oscillate or self-destruct with shorts or opens

S-parameters

- Relate to familiar measurements (gain, loss, reflection coefficient, etc.)
- Relatively easy to measure
- Can cascade S-parameters of multiple devices to predict system performance
- Analytically convenient
 - CAD programs
 - Flow-graph analysis
- Can compute H, Y, or Z parameters from S-parameters if desired

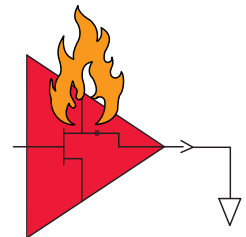

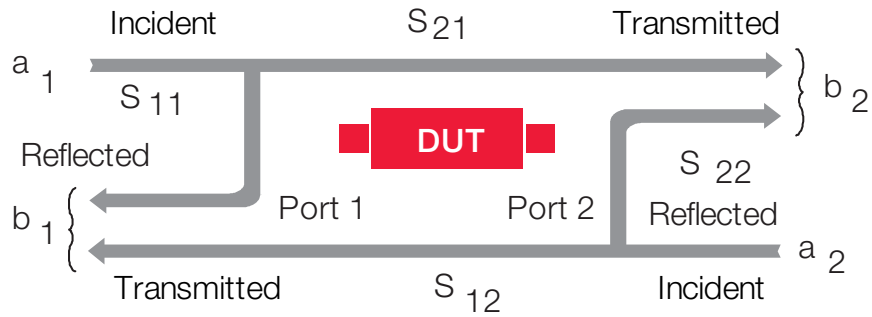

$$b_1 = S_{11} a_1 + S_{12} a_2$$

$$b_2 = S_{21} a_1 + S_{22} a_2$$

Figure 16. Limitations of H, Y, and Z parameters (Why use S-parameters?)

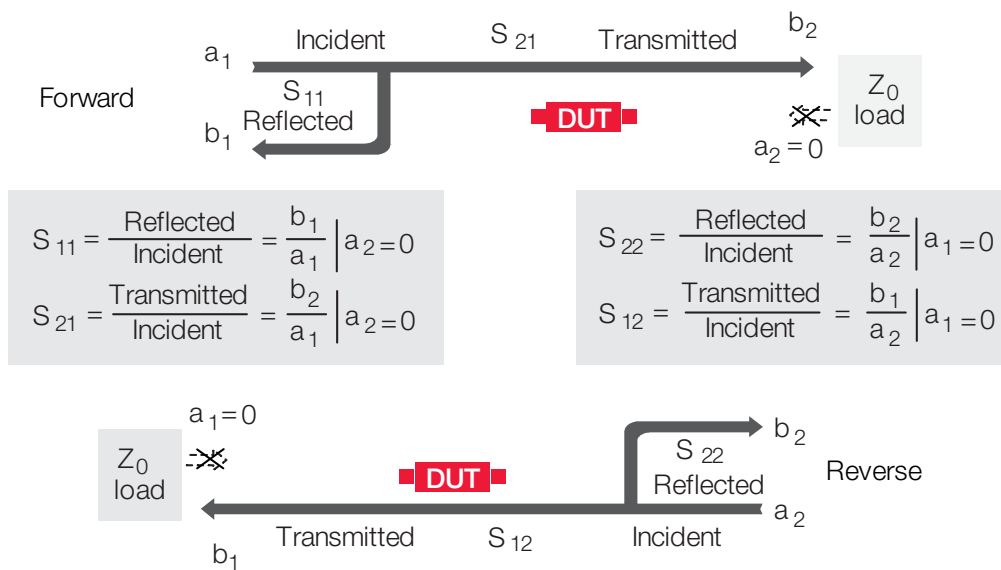

Figure 17. Measuring S-parameters

Forward S-parameters are determined by measuring the magnitude and phase of the incident, reflected, and transmitted signals when the output is terminated in a load that is precisely equal to the characteristic impedance of the test system. In the case of a simple two-port network, S_{11} is equivalent to the input complex reflection coefficient or impedance of the DUT, while S_{21} is the forward complex transmission coefficient. By placing the source at the output port of the DUT and terminating the input port in a perfect load, it is possible to measure the other two (reverse) S-parameters. Parameter S_{22} is equivalent to the output complex reflection coefficient or output impedance of the DUT while S_{12} is the reverse complex transmission coefficient (Figure 17).

Related Literature

Exploring the Architectures of Network Analyzers, Application Note, literature number 5965-7708E

Applying Error Correction to Network Analyzer Measurements, Application Note, literature number 5965-7709E

Network Analyzer Measurements: Filter and Amplifier Examples, Application Note, literature number 5965-7710E

Web Resources

Vector Network Analyzer: www.keysight.com/find/na

PNA Series Vector Network Analyzers: www.keysight.com/find/pna

ENA Series Vector Network Analyzers: www.keysight.com/find/ena

PXI Vector Network Analyzers: www.keysight.com/find/pxivna

Calibration Kits and ECal Modules: www.keysight.com/find/ecal



For more information on Keysight Technologies' products, applications, or services, please visit: www.keysight.com

This information is subject to change without notice. © Keysight Technologies, 2022, Published in USA, August 10, 2022, 5965-7707EN